

Vacuum Switch Diaphragm Style

Series ZSM1-115/121



For details about certified products conforming to international standards, visit us at www.smcworld.com.



Specifications

Model	ZSM1-115	ZSM1-121
Switch specifications	Solid state	Contact (Reed switch)
Fluid	Air/Inert gas	
Max. operating pressure	0.5 MPa	
Regulating pressure range	-27 to -80 kPa	
Hysteresis	Max. 15 kPa	Max. 20 kPa
Repeatability	±10% or less	
Ambient and fluid temperature	-5 to 60°C (No freezing)	
Supply voltage	4.5 to 28 VDC	100 VAC/DC or less
Indicator light	ON: When output is ON.	
Lead wire	3	2
Port size	R 1/8	
Mass	65 g	

Electrical Specifications

ZSM1-115

Supply voltage	4.5 to 28 VDC
Output (Open collector)	28 V, Max. 40 mA
Current consumption	10 mA or less (24 VDC)

ZSM1-121

Supply voltage	100 VAC/DC
Max. operating current range	24 V or less: 50 mA, 48 V: 40 mA, 100 V: 20 mA
Max. contact capacity	AC 2 VA, 2 W DC

How to Order

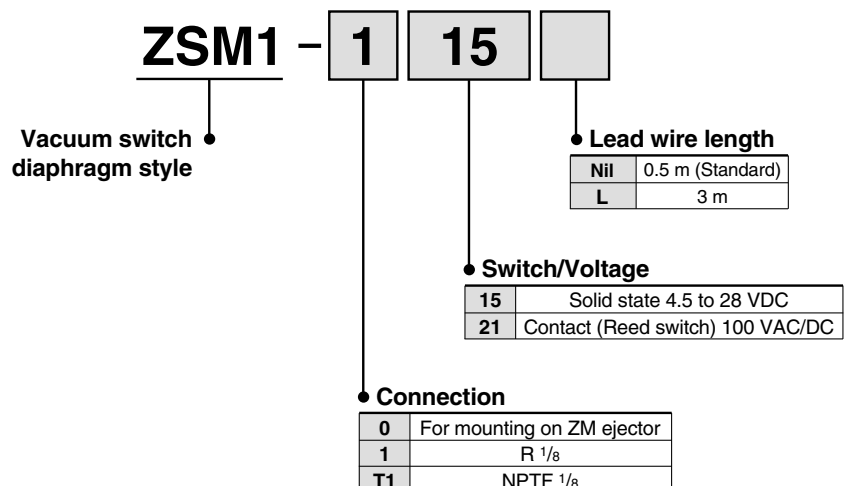

Vacuum Switch Diaphragm Style *Series ZSM1-115/121*

Internal Circuit

ZSM1-115

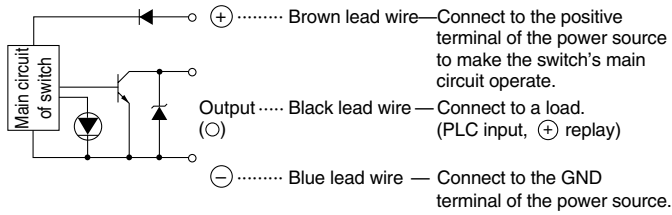

ZSM1-121

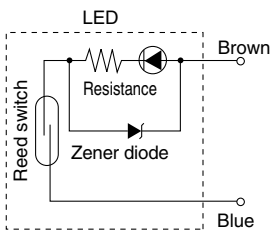

Wiring

ZSM1-115

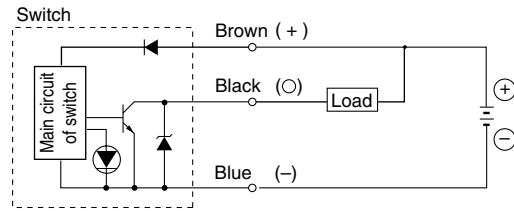

Connection example with PLC

In the case of common terminal is "⊖" negative

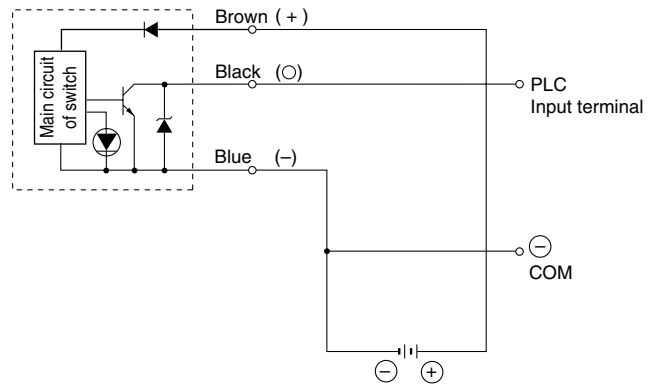

Dimensions

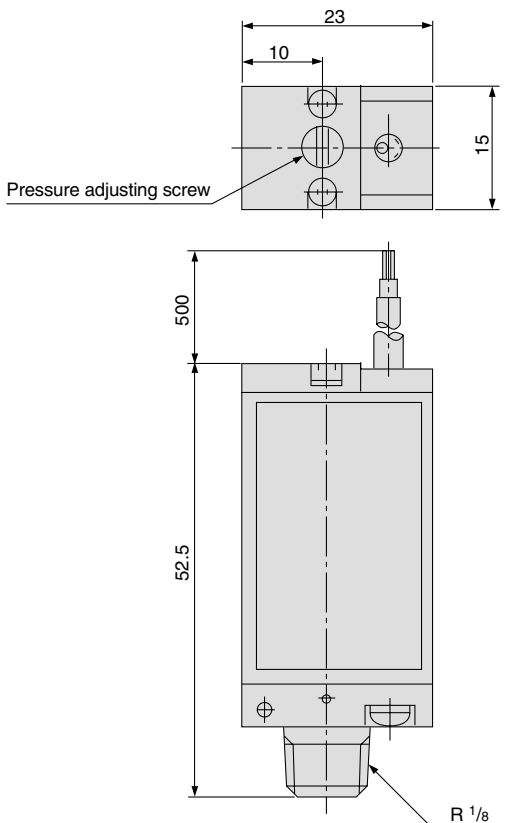

ZSM1-115

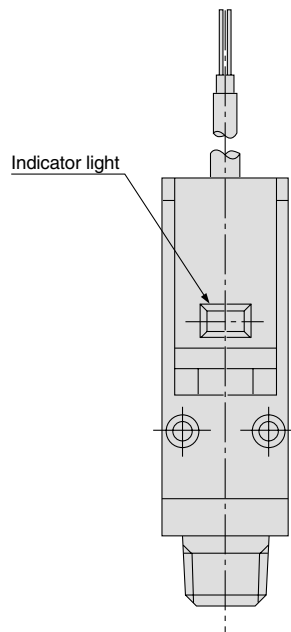

ZSM1-121

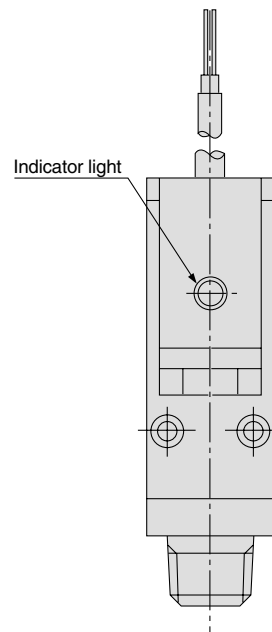

ZSE
 ISE
 ZSP
 PS
 ISA
 PSE
 IS
 ISG
 ZSM



Series ZSM1-115/121 Specific Product Precautions

Be sure to read before handling. Refer to front matters 58 and 59 for Safety Instructions and pages 687 to 691 for Pressure Switch Precautions.

Wiring

⚠ Warning

- Do not apply excessive pulling force on the lead wire. It may cause a malfunction or damage.
- Wiring of ZSM1-121**
Switches may be connected in series, voltage drop will be increased by the LED's internal resistance (2 V drop per each). Use switches within the specified range of min. operating voltage.
- Diaphragm switches have no built-in contact protection circuits. Use switches with contact protection box (part no. CD-P11) with inductive loads or 5 m or more lead wire length.
- Internal circuit of contact protection box**

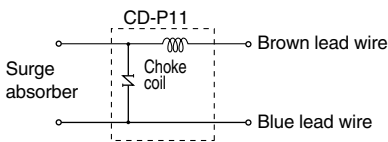

5. How to connect the contact protection box

Connect the lead wires from the body and the contact protective box side indicated "SWITCH". Lead wire should be as short as possible, within 1 m.

Installation/Piping

⚠ Caution

- When piping switch by hand, hold body. Electrical wire must not be subjected to excessive force.
- Do not drop nor apply excessive force. It may cause malfunction or damage.
- Tighten switch by applying the wrench on the fitting part. Turning it by applying a wrench on the main body may cause damage to the product.
- Mounting is possible in either horizontal or vertical orientation.

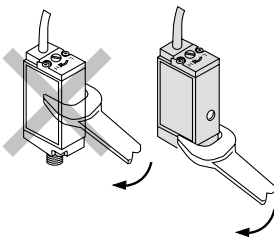

Pressure Source

⚠ Warning

- Do not absorb water, etc. when using as an adsorption confirmation switch. It may result in a malfunction or damage.
- Operating fluids are either air or inert gas exclusively. It cannot be used with corrosive fluids.

Pressure Setting

⚠ Warning

1. Setting of vacuum pressure

Set the possible minimum pressure for adsorption when used for adsorption confirmation. If setting the pressure lower than that, switch becomes ON in case when adsorption is not complete. If setting the pressure higher than that, switch does not become ON though it is absorbing workpieces properly.

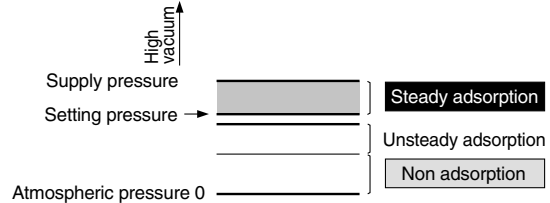

2. Hysteresis

Hysteresis is the pressure difference between the ON pressure and the OFF pressure of the output signal. The set pressure is the pressure selected to switch from OFF to ON condition.

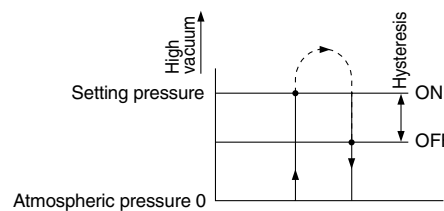

3. Number of rotations of pressure adjusting screw

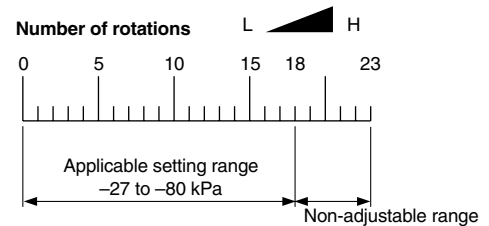

Max. number of rotations are 18.

⚠ Caution

1. How to Set Vacuum Pressure

The pressure setting trimmer is used to set the on-pressure. Clockwise rotation increases the on-pressure setting.

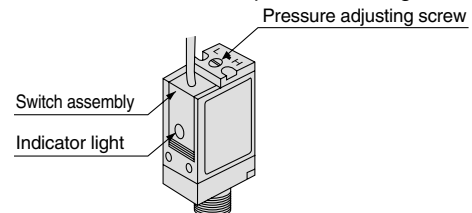

Operating Environment

⚠ Warning

- Not able to use it under the influence of a magnetic field. Affected by the magnetic field, and result in a malfunction.
- Do not use in such an environment where water or oil is splashed.
Since it is the open type construction, if water or oil make an ingress into the internal parts, the electric circuit will be corroded and may result in malfunction or damage.
- Never use switch in an environment where flammable fluid or gas is used.
It may result in an explosive disaster, since it is not explosion-proof construction.

Glossary of Terms/Technical Information

Glossary of Terms

A

Absolute pressure.....	
Accuracy.....	
Analog output function.....	P. 876
Auto preset function.....	
Auto shift function.....	

C

Chattering.....	
Condensation.....	
Connection port size.....	P. 876
Connector.....	
Current consumption.....	

D

Detection range.....	
Diffusion type semi-conductor pressure sensor.....	P. 876
Digit (Minimum displayable unit).....	
Digital pressure switch.....	
DIN rail.....	

E

Ejector.....	P. 876
Extended analog output.....	

F

F.S.....	
Failure predict output function.....	
Frequency response.....	P. 876
Full scale.....	
Full span.....	

G

Gas contact part.....	
Gauge pressure.....	P. 876
Grommet.....	

H

Hysteresis.....	P. 877
Hysteresis mode.....	

I

Input impedance.....	
Insulation resistance.....	P. 877
Internal voltage drop.....	

K

Key lock mode.....	P. 877
--------------------	--------

L

Leakage current.....	
LED level meter.....	
Liquid contact part.....	
Load.....	P. 877
Load current.....	
Load impedance.....	
Load lock chamber.....	
Load voltage.....	

M

Maximum operating pressure.....	
Minimum displayable.....	P. 877
Minimum setting pressure unit (digit).....	

N

Noise resistance.....	
Normal mode.....	P. 877
NPN output.....	

O

ON-OFF output.....	
Open collector.....	
Operating humidity range.....	
Operating indicator light.....	P. 877
Operating pressure range.....	
Operating temperature range.....	
Orifice.....	

P

Panel-mounting.....	
Peak high display mode.....	
Peak low display mode.....	P. 878
PNP output.....	
Proof pressure.....	
Protective construction.....	

R

Reducer.....	
Reed switch.....	
Relative pressure.....	
Repeatability.....	P. 878
Residual voltage.....	
Response time.....	
Reversed output mode.....	
Ripple.....	

S

Self-diagnostic function.....	
Sequence controller (PLC).....	
Shock resistance.....	
Solid state switch.....	P. 878
Stainless diaphragm.....	
Suction filter.....	
Supply power voltage.....	
SUS ***.....	
Switch output.....	

T

Temperature characteristics.....	
The amount of leakage.....	P. 879
TSJ.....	
Turning angle of setting trimmer.....	

U

Unit conversion.....	P. 879
URJ.....	

V

Vacuum breaking pressure.....	
Vibration resistance.....	P. 879
Voltage resistance.....	

W

Window comparator mode.....	P. 879
-----------------------------	--------

Z

Zero out (Zero ADJ).....	P. 879
--------------------------	--------

0-9

2-wire type pressure switch.....	P. 879
----------------------------------	--------

Technical Information

1	Outline	
2	How pressure is detected	P. 880
3	Difference between ON-OFF and Analog output	
4	Difference between NPN and PNP output	P. 881
5	Hysteresis mode	
6	Window comparator mode	P. 882
7	Peak high and peak low display modes	
8	Temperature characteristics	P. 883
9	Repeatability	
10	Failure predict function	P. 884
11	Auto preset function	
12	Auto shift function	P. 885
13	2-wire pressure switch connections	P. 886
14	Voltage and current output pressure sensors	P. 887
15	Protective construction	
16	Pressure units conversion (Approximation)	P. 888
17	Operable fluids by pressure switch for general purpose fluids	

ZSE
ISE

ZSP

PS

ISA

PSE

IS

ISG

ZSM

Glossary of Terms

A

Absolute pressure

The pressure based on the absolute vacuum condition (0 standard).

Accuracy

The maximum difference between the true value and that indicated by an instrument is the measure of the instrument's accuracy. It is expressed as a percentage of the full-scale value of the reading according to the type of instrument.

Analog output function

A voltage or current output which has a value proportional to the measured pressure.

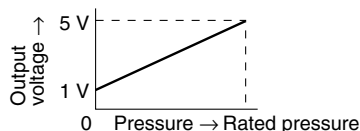

Auto preset function

Refer to "Technical Information" on page 884 [11](#).

Auto shift function

Refer to "Technical Information" on page 885 [12](#).

C

Chattering

If the ON and OFF setpoints are of identical value with no hysteresis, "chattering" occurs. Chattering refers to the repeated change of an output from "High" to "Low" at a high frequency.

Condensation

Natural phenomenon. Humidity in the air collects on colder surfaces and liquefies.

Connection port size

Size of the process connection on the switch.

Connector

Type for wiring by a lead wire with a connector.

Current consumption

Maximum current needed for normal operation. Does not include the load current.

D

Detection range

Distance at which an instrument such as the Air Catch Sensor is operational.

Diffusion type semi-conductor pressure sensor

Pressure sensor, which sensor part (sensor chip) for detecting the pressure is formed by the diffusion resistance on a diaphragm made of silicone.

Digit (Minimum displayable unit)

When displaying pressure by Digital Pressure Switch, it indicates how fine it can display or set. In case of 1 digit = 1 kPa, it is displayed like 1, 2, 3 . . . 99, 100, with displaying every 1 kPa.

Digital pressure switch

The pressure switch manages signals via a sensor using a micro computer like a CPU, it indicates pressure value in digital output, ON-OFF.

DIN rail

The rail equivalent to DIN Standard in Germany. The products introduced in this catalogue are corresponding to 35 [mm] width type.

E

Ejector

Simple piece of equipment to generate a vacuum. Positive air pressure is used to generate a vacuum. No moving parts.

Extended analog output

Pressure range that exceeds the rated pressure range, which analog output corresponds.

F

F.S.

F.S. is the abbreviation for Full Span or Full Scale. The maximum fluctuation width.

EX.) When output voltage is 1 to 5 [V],

$$\text{F.S.} = \text{The max. voltage} - \text{The min. voltage}$$

$$= 5 \text{ [V]} - 1 \text{ [V]}$$

$$= 4 \text{ [V]}$$

(Reference: 1% F.S. = 4 x 0.01 = 0.04 [V])

Failure predict output function

Refer to "Technical information" on page 884 [10](#).

Frequency response

The inverse number of response time. The higher the frequency becomes, the shorter the response time becomes.

Full scale

Same meaning as F.S.

Full span

Same meaning as F.S.

G

Gas contact part

Wetted parts. Parts that are in contact with the process gas.

Gauge pressure

Pressure converted as the atmospheric pressure to be the reference value (0).

Grommet

No worry about coming it off with vibration, etc.

H

Hysteresis

The difference between the “OFF” state and “ON” state value at a given setpoint value.

Hysteresis mode

Refer to “Technical Information” on page 882 [5].

I

Input impedance

The impedance at the input terminals of a circuit, transmission line, etc., “seen” by a signal source, expressed in ohms.

Insulation resistance

Resistance between electrical circuit and the body.

Internal voltage drop

Caused by the resistance of an electrical part in an electronic circuit. Example is a 2-wire pneumatic pressure switch.

K

Key lock mode

It is the function to prevent from malfunctioning. Commands other than unlocking key lock mode by pressing the button can not to be accepted.

L

Leakage current

Current flow at the “OFF” state. Ideally, this value is “0”.

LED level meter

The indicator light which shows how much the current value differs from the setting value in the Air Catch Sensor.

Liquid contact part

Wetted parts. Parts that are in contact with the process fluid.

Load

Electrical appliance connected to the output, e.g. relay, solenoid, etc.

Load current

Current flow through the electrical appliance once the output is energized.

Load impedance

Resistance of the load that impedes the current flow.

Load lock chamber

Vacuum chamber located in front of the main vacuum chamber in semiconductor production line. Prevents main vacuum chamber to be contaminated (loss of vacuum) during the loading and unloading process.

Load voltage

Voltage supplied to load.

M

Maximum operating pressure

Maximum operating pressure the unit is designed for. Exceeding this pressure could result in malfunction or damage to the unit.

Minimum displayable pressure unit (digit)

Minimum unit to indicate pressure. If the min. display unit is 1 [kPa], display indicates in each 1 [kPa] (by [kPa]) i.e. 0, 1, 2, 3 ... 99, 100 [kPa].

Minimum setting pressure unit (digit)

The least possible unit to set pressure value on the digital pressure switch. If the minimum setting unit is 1 [kPa], setting is possible only with integer multiples of that number i.e. 1, 2, 3 ... (Not available 1.5, 2.5 ...).

N

Noise resistance

Amount of electrical noise, an electrical appliance can withstand without malfunctioning.

Normal mode

Refer to “Technical Information” on page 882 [5], [6].

NPN output

Refer to “Technical Information” on page 881 [4].

O

ON-OFF output

Refer to “Technical Information” on page 880 [3]. Switch output.

Open collector

Internally the output wire and terminal are directly connected to collector of output transistor. (Refer to Fig. (1) and (2).)

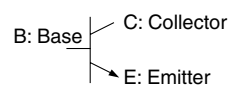

Fig. (1) NPN type

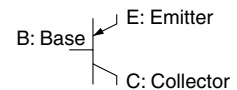

Fig. (2) PNP type

Operating humidity range

Humidity range for normal operation.

Operating indicator light

LED indicator is on when ON-OFF output is ON.

Operating pressure range

Pressure range. The unit was designed to operate in.

Operating temperature range

Temperature range for normal operation.

Orifice

Restriction for controlling flow of fluid.

ZSE
ISE
ZSP
PS
ISA
PSE
IS
ISG
ZSM

Glossary of Terms

P

Panel mounting

To allow a product to be mounted on a panel in an appealing and secure fashion.

SMC panel mount type is designed in advance for easy installment on a panel.

Peak high display mode

Refer to “Technical Information” on page 882 [7].

Peak low display mode

Refer to “Technical Information” on page 882 [7].

PNP output

Refer to “Technical Information” on page 881 [4].

Proof pressure

A pressure exceeding the upper limit. It will result in damage to product.

Protective construction

Refer to “Technical Information” on page 887 [15].

R

Reducer

One of the connection types. Connect directly to the “One-touch” fittings.

Reed switch

Type of switch in which two strips of magnetic material sealed inside a glass tube are caused to come into contact by the magnetic field of a nearby magnet.

Relative pressure

Converted pressure value based on any own decided standard pressure. When based on the absolute vacuum, it is called Absolute Pressure, while based on the atmospheric pressure, it is called Gauge Pressure.

Repeatability

Refer to “Technical Information” on page 883 [9].

Residual voltage

Voltage occurred in COM and output when the switch output is in ON state. It varies depending on an applied load current. It is ideal to be “0”.

Response time

The inverse number of frequency response. The shorter the response time becomes, the higher the frequency becomes.

Reversed output mode

Refer to “Hysteresis mode” and “Window comparator mode” in “Technical Information” on page 882 [5], [6].

Ripple

A small AC voltage superimposed on top of DC voltage.

In the case of Fig. (3), ripple 10% means

$$V' \geq V''$$

$$V'/V \times 100 = 10\%$$

When no pulsation has occurred, ripple is 0%.

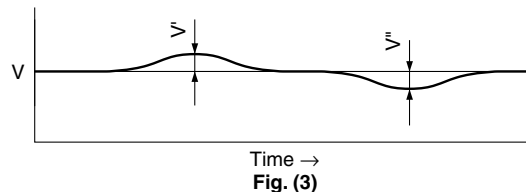

S

Self-diagnostic function

Error message is displayed if the unit is operated outside its designed operational envelope.

Sequence controller (PLC)

Programmable logic controller. Depending on application, it can utilize inputs from pressure or limit switches and control outputs executing a control program down loaded in its memory.

Shock resistance

The amount or severity of shock, an appliance can withstand without damage.

Solid state switch

Typically a transistor. A solid state switch does not have any mechanical parts.

Stainless diaphragm

Material of a diaphragm for detecting pressure is made of stainless steel.

Suction filter

Filter installed between the vacuum pad and the ejector to prevent dust entry to the ejector.

Supply power voltage

Voltage range for normal operation.

SUS ***

JIS symbol classifying the grade of stainless steel.

Switch output

Refer to “Technical Information” on page 880 [3], ON-OFF output.

T

Temperature characteristics

Refer to “Technical Information” on page 883 [8].

The amount of leakage

As an example, testing for detecting leakage is called a leak test.

TSJ

Abbreviation of Tube Swage Joint. We recommend the Swagelok® fitting made by Swagelok Company be used.

* Swagelok® is a registered trademark of Swagelok Company.

Turning angle of setting trimmer

The maximum number of turns of the trimmer when adjusting the setpoint. The greater the turning angle, the finer the possible adjustments.

U

Unit conversion

Refer to “Technical Information” on page 888 [16].

URJ fitting

Abbreviation of Union Ring Joint. We recommend the VCR® fitting made by Swagelok Company be used.

* VCR® is a registered trademark of Swagelok Company.

V

Vacuum breaking pressure

Positive pressure added for releasing the work or quickly returning to atmospheric pressure after breaking the vacuum condition.

Vibration resistance

The amount of vibration a device can withstand without damage.

Voltage resistance

Maximum voltage level when voltage runs between electrical circuit and body. The value indicates strength against voltage. If higher voltage runs, product may be damaged. (In this case, voltage is different from power supply voltage to operate product.)

W

Window comparator mode

Refer to “Technical Information” on page 882 [6].

Z

Zero-out

Reset of the display to zero at atmospheric pressure.

0-9

2-wire type pressure switch

Refer to “Technical Information” on page 886 [13].

ZSE
ISE

ZSP

PS

ISA

PSE

IS

ISG

ZSM

Technical Information

1 Outline

The Pressure Switch detects pressure of gases or liquids. Built-in circuitry allows for the adjustment of set points and outputs. Outputs are ON-OFF solid state or reed switch type outputs. Some models feature analog outputs. The pressure is detected using solid state, metal diaphragm or piston type sensors. Applications for pressure switches are numerous and include areas such as positioning, leakage testing, supply pressure verification, etc.

2 How pressure is detected

● Solid state sensor

This sensor is used in dry air and inert gas applications. Four diffused resistors form a bridge circuit on a silicon diaphragm. When pressure is applied, the diaphragm is deflected causing the diffused resistors to change resistance (piezoelectric effect). An electrical signal, which is proportional to the pressure change, is inputted during normal operation.

Characteristics: Quick response
Long service life
Compact

● Stainless steel diaphragm pressure sensor

This sensor is used in humid air, water or oil. Four diffused resistors form a bridged circuit on a stainless steel diaphragm. All pressured parts are made of stainless steel. Pressure detection is identical to the silicon diffused sensor with the exception that the resistors are diffused on to the stainless steel diaphragm.

Characteristics: Quick response
Long service life
Wide variety of applicable fluid

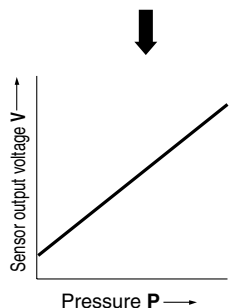
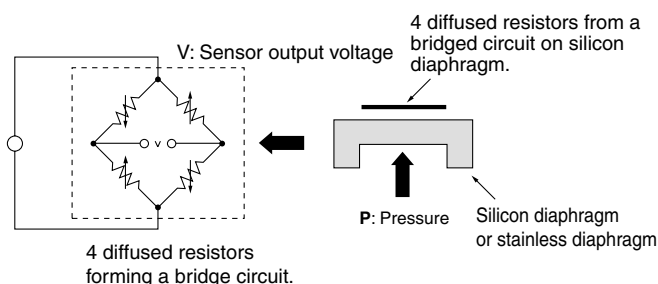

When diaphragm is deformed by applying pressure, resistance value of diffused resistor varies and therefore sensor output does too, due to piezoelectric effect. As the pressure increases, sensor output voltage becomes larger. (Refer to the graph left.)

3 Difference between ON-OFF and Analog output

● ON-OFF output

ON-OFF output is also referred to as switch output. Fig. (1) shows an equivalent circuit of a NPN switch with the output off. In this circuit the load is not powered, because there is no current flow. Negative potential is not connected.

When using a PLC, the input section sees a high level.

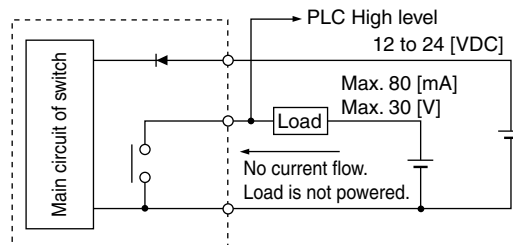

Fig. (1) Equivalent circuit of a NPN type switch with the output off

Fig. (2) shows an equivalent circuit of a NPN switch with the output on. In this circuit the load is powered. Besides, the input part of PLC becomes low level. PLC detects the signal change from high to low and then can proceed to the next process. The point at which the output is switched is variable freely within the allowable setting range. For the ON-OFF output, there is a PNP type beside a NPN type. About the difference between NPN and PNP, refer to page 881.

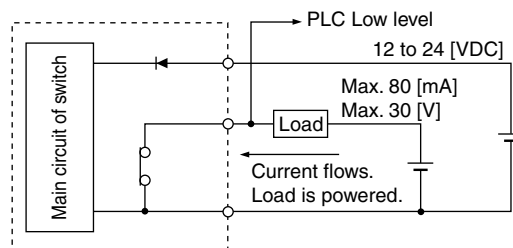
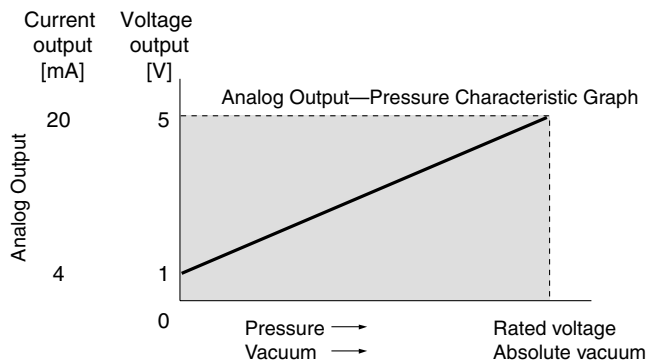

Fig. (2) Equivalent circuit of a NPN type switch with the output on

● Analog output

An analog output provides an output that is proportional to the pressure measured by the sensor.



4 Difference between NPN and PNP output

● NPN

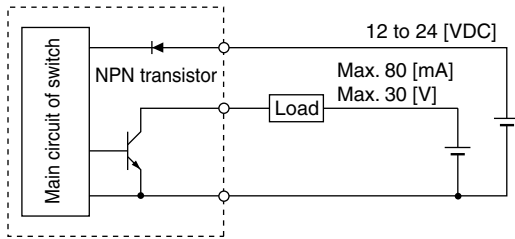

Fig. (1) Connection example of NPN output

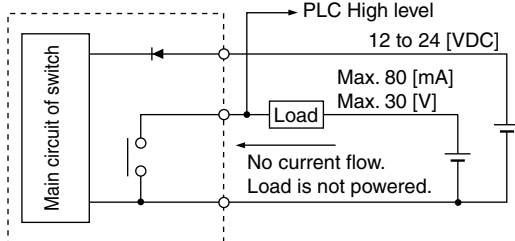

Fig. (2) Equivalent circuit of an NPN switch with the output off

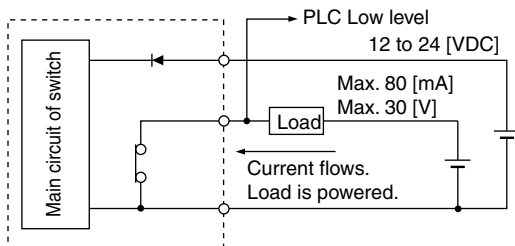

Fig. (3) Equivalent circuit of an NPN switch with the output on

● PNP

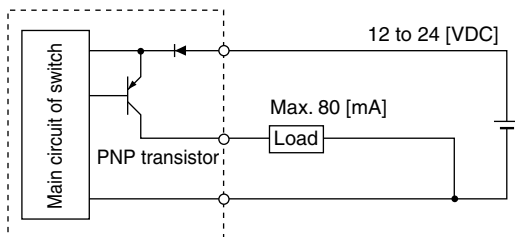

Fig. (4) Connection example of PNP output

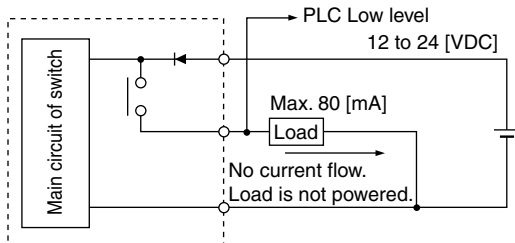

Fig. (5) Equivalent circuit of a PNP switch with the output off

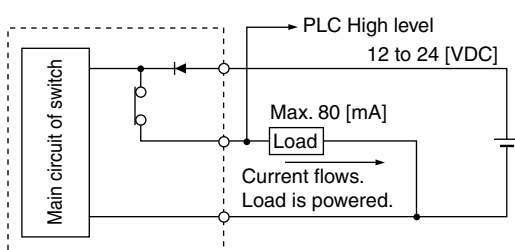

Fig. (6) Equivalent circuit of a PNP switch with the output on

Fig. (1) shows an example of a NPN switch. The solid state switch output is an open collector output. The NPN refers to type of output transistor used. Fig. (3) shows the equivalent circuit with the output transistor in its ON state. The current for the load flows in (sinks) to the transistor. The NPN type of output is also referred to as the "Sinking Type". In order for this circuit to work, the other side of the load has to be connected to the positive terminal of a power source. The diagram on the left shows two power sources, one for the load and one for the switch. In actual applications it will cause no problem to use one source for both.

Summary: An NPN output has the current flowing from the load into the transistor when energized. (Sinking type) (PLC uses the one for VaCOM.)

Fig. (4) shows an example of a PNP switch. The solid state switch output is an open collector type output. The PNP refers to the type of output transistor used. Fig. (6) shows the equivalent circuit with the output transistor in its ON state. The current for the load flows out (sources) of the transistor. The PNP type of output is also referred to as the "Sourcing Type". In order for this circuit to work the other side of the load has to be connected to the negative common.

Summary: A PNP output has the current flowing from the transistor to the load when energized. (Sourcing type) (PLC uses the one for GND COM.)

ZSE
ISE
ZSP
PS
ISA
PSE
IS
ISG
ZSM

Technical Information

5 Hysteresis mode

Hysteresis is the difference between the ON and OFF value of an output. This is necessary to prevent the switch from "Chattering" once the setpoint is reached. In the case of "Normal Mode", the output remains ON until the pressure falls to a level below the setpoint minus the hysteresis. This means the output will be turned off at a specific pressure which can be calculated as follows:

$$\text{OFF switch point} = \text{setpoint} - \text{hysteresis}$$

"Reversal Mode" is defined as: ON switch point = setpoint - hysteresis

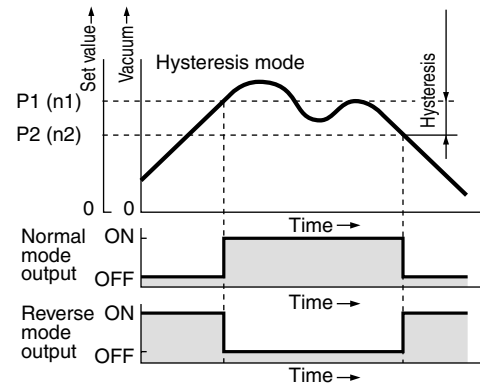

6 Window comparator mode

This mode is used when the output has to stay ON within a certain pressure range. The hysteresis is fixed (3 digits). When calibrating the switch, make sure that calibration point P1 is at least 7 digits different from calibration point P2. The effective area of operation is shown in the graph and is marked with "L". If the difference between P1 and P2 is less than 6 digits, this mode will not operate. (Hysteresis varies depending on the product series. It should be set after confirming the specifications for each series.)

In the case of a switch with 2 outputs, the Output 2 is using calibration points P3 and P4. Reversal Mode reverses above operation. Window Comparator Mode can be applied in situations where the supply pressure has to be within a certain range.

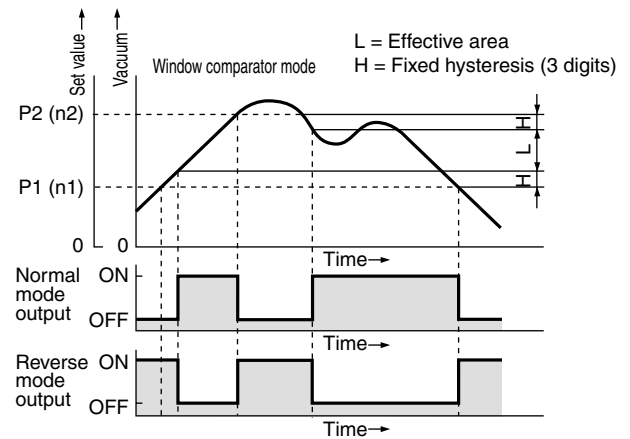

7 Peak high and peak low display modes

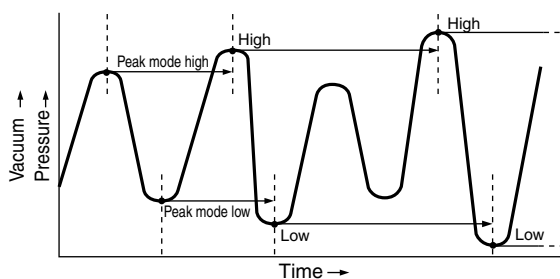

Under most operating conditions the pressure will vary over time (see graph). The highest pressure measured is stored and displayed as "Peak Mode High". The lowest pressure measured is stored and displayed as "Peak Mode Low".

8 Temperature characteristics

The temperature characteristic is defined as the change in linearity over a given temperature range. All data given in a technical specification sheet is based on 25[°C]. The temperature range is dependent on the product series. Normally SMC products are rated from 0 to 50[°C] or 0 to 60[°C].

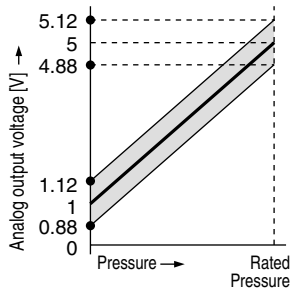

Example) When the property at the temperature characteristic condition ± 3.0 [% F.S.] and 25[°C] is expressed by the bold line in the chart above, how much temperature effect will the analog output voltage receive? It can be determined.

Example: Analog output = 1 to 5 [V]
 F.S. = 5 [V] - 1 [V] = 4 [V]
 ± 3 [% F.S.] = 4 x 0.03 = ± 0.12 [V]

The output error induced by the temperature change can be as much as ± 120 [mV]. Since this is the maximum value, the error will actually occur within the range enclosed by the thin line in the chart above.

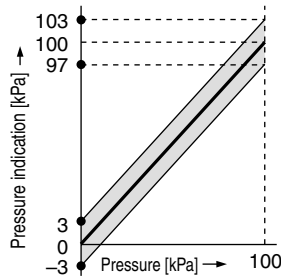

Example) When the property at the temperature characteristic condition ± 3.0 [% F.S.] and 25[°C] is expressed by the bold line in the chart above, how much temperature effect will the analog output voltage receive?

The chart above illustrates the example when 100 [kPa], F.S. = 100 - 0 = 100 [kPa], ± 3.0 % F.S. = 100 x 0.03 = ± 3 [kPa]. It means that if the temperature is changed within the range of 0 to 50[°C], the error will occur at the max. ± 3 [kPa]. Since this is the maximum value, the error will actually occur within the range enclosed by the thin line in the chart above.

We explained by giving 2 examples. As for temperature characteristics, the smaller this value is, the smaller the error would be. That means it is strong against the temperature changes.

9 Repeatability

The repeatability is defined as the ability of an instrument to provide the same output every time for the same input. Usually given as a percentage of the full scale value.

Example: Full scale reading 100 [kPa] Setpoint for output 50 [kPa]

Repeatability ± 1 [% F.S.]

F.S. = 100 [kPa] - 0 [kPa] = 100 [kPa]

± 1 [% F.S.] = 100 [kPa] x 0.01 = ± 1 [kPa]

The deviation from the setpoint is ± 1 [kPa]. This means that the output can become energized anywhere between 49 to 51 [kPa]. (Refer to the chart below.)

Note: If the pressure switch allows an error of 1 [% F.S.], the output turns ON at 51 [kPa]. Taking the repeatability into account, the output turns ON at 50 to 52 [kPa] and, in the same way, the pressure display turns 50 [kPa] at 49 to 51 [kPa]. (Refer to the chart below.)

Thus, the smaller the repeatability, the more precision in reproduction the product achieves.

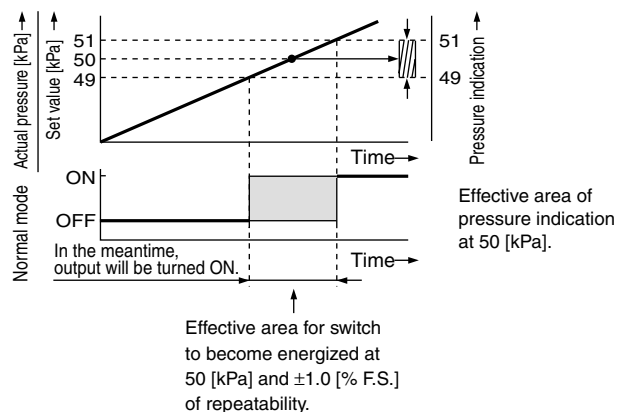

Effective area of pressure indication at 50 [kPa].

Effective area for switch to become energized at 50 [kPa] and ± 1.0 [% F.S.] of repeatability.

ZSE
 ISE
 ZSP
 PS
 ISA
 PSE
 IS
 ISG
 ZSM

Technical Information

10 Failure predict function

In the case of performance decrement caused by clogging up the silencer of vacuum system (ejector), cracking of vacuum pad, or decreasing the vacuum reaching degree by leakage from vacuum piping, it detects the abnormality quickly and send out the output to the outside right before the system comes to a stop.

In case the ON-OFF output is in the normal mode, when the failure predict output switches ON (over P1), and the pressure turns OFF without reaching the failure predict pressure (P3), the number of failure predict detection is counted. When it is consecutively counted up to the failure predict numbers (EC) preset, the failure predict output will turn ON. When a switch turns ON, (over P1) and the pressure exceeds the failure predict pressure (P3), the count of failure predict numbers will be reset.

Ex.) When an error count (number of the failure predict) (EC) is set to be 3.

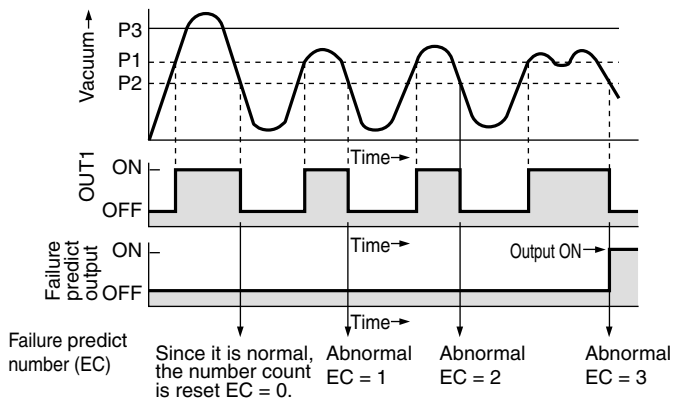

11 Auto preset function

Auto preset function enables automatic selection of the optimum set point value when the pressure switch is used for adsorption confirmation simply by repeating the adsorption and release cycle with the workpiece. Refer to the catalog and instruction manual for how to enter the auto preset mode. This section describes calculation of the set value.

How to Calculate the Set Value

A = Max. pressure value in auto preset mode

B = Tentative min. pressure value in auto preset mode

$$P1 = A - (A - B)/4$$

$$P2 = B + (A - B)/4$$

Manual adjustment is possible after finishing in the auto preset mode.

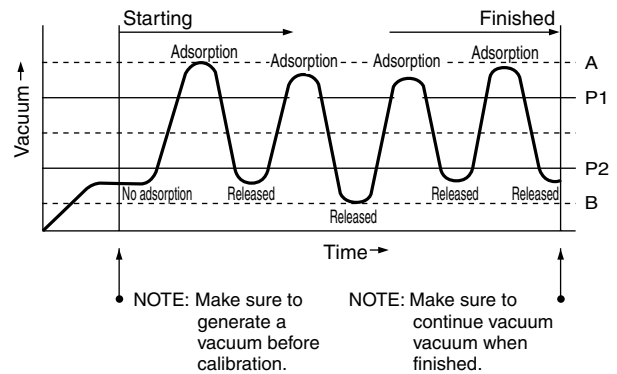

12 Auto shift function

The auto shift function is the function to regard the pressure value at the point of this signal being input as the benchmark and to display and conduct switching. For example, it will be used to take countermeasures against the main line pressure fluctuation. If the main line pressure is fluctuated, the performance of an ejector will vary and also the pressure will change at the non-adsorption case. Therefore, the phenomenon that switching is not done will take place, even if a workpiece is in suction. (Refer to the chart below.) The auto shift function is utilized like this case.

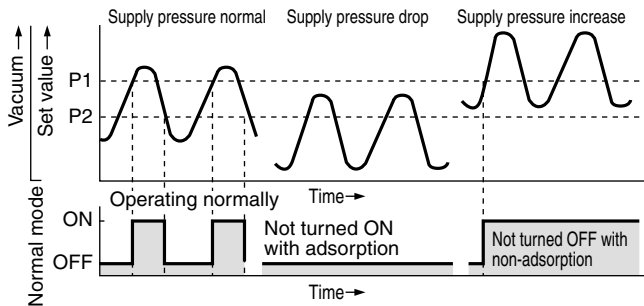

When the Auto Shift Function is NOT used.

If the auto shift function is used, switching will be done by regarding the point of this signal being input as the benchmark. Therefore, switching can be surely done as long as the auto shift signal is being input at the non-adsorption case.

In case the auto shift is not at all used, switching is done just on the basis of either larger or smaller than the set value. Meanwhile, when the auto shift is used, switching will be done by whether to fluctuate by the set value from the benchmark (from the time of inputting auto shift). (Refer to the chart below.)

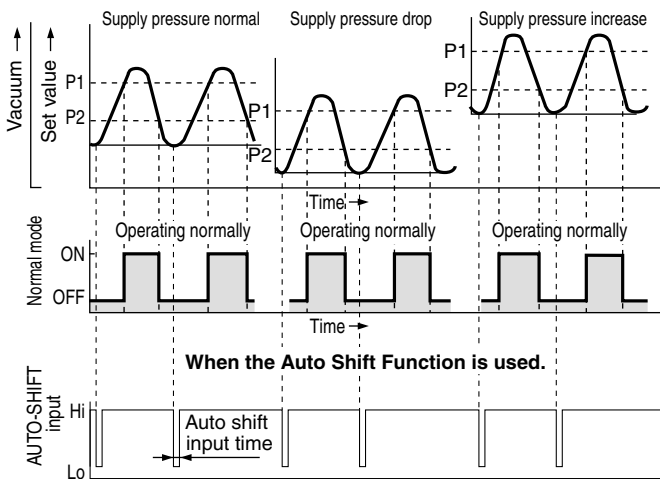

Note) Auto shift input time
 Series PSE 200: 10 [ms] or longer
 Other series: 5 [ms] or longer

Another application for the auto shift function would be the testing for leaks. Under normal circumstances a vessel charged with compressed air to a certain pressure will stay pressurized at the same pressure level unless the vessel has a leak. If the vessel has a small leak the pressure will decrease over time. No vessel is absolutely leakproof, therefore leakage testing is done measuring the amount of pressure drop over a period of time. Using a pressure switch, an output can be generated as soon as the pressure level decreases by 1 [kPa], for example. Without the Auto shift function the vessel has to be charged to the exact pressure level every time. If the initial pressure level is too high the output of the switch does not become energized at all or becomes energized after an excessive amount of time. If the pressure is too low the output is always energized. In either case it is impossible to determine if the vessel is good or bad.

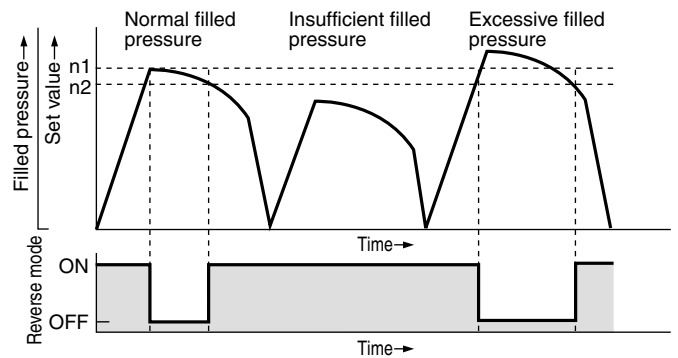

When the Auto Shift Function is NOT used.

To combat fluctuations in initial pressure level, the auto shift feature is activated as soon as the vessel is charged. The initial pressure level is now used as a reference. As soon as the pressure drops by 1 [kPa] (see example above) from the point at which the auto shift feature is activated, the output is energized. Refer to the chart below.

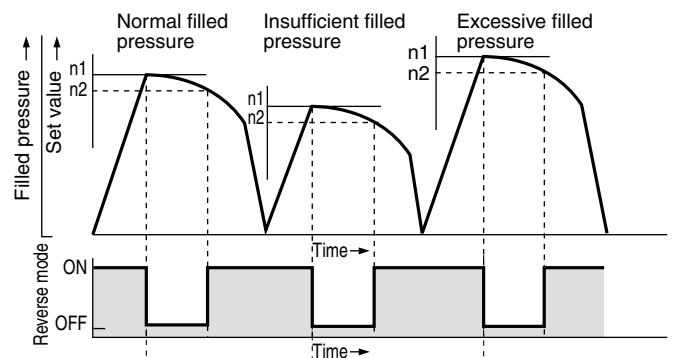

When the Auto Shift Function is used.

Note) Auto shift input time
 Series PSE 200: 10 [ms] or longer
 Other series: 5 [ms] or longer

- ZSE
- ISE
- ZSP
- PS
- ISA
- PSE
- IS
- ISG
- ZSM

Technical Information

12 Auto shift function

How to Activate the Auto Shift Function

Connect the auto shift input with GND for at least 5 [ms] (PSE200: at least 10 [ms]).

Based on the pressure at this moment, switching will be done.

Example: The figure below is based on the condition of set values as P1 = 40 [kPa] and P2 = 20 [kPa].

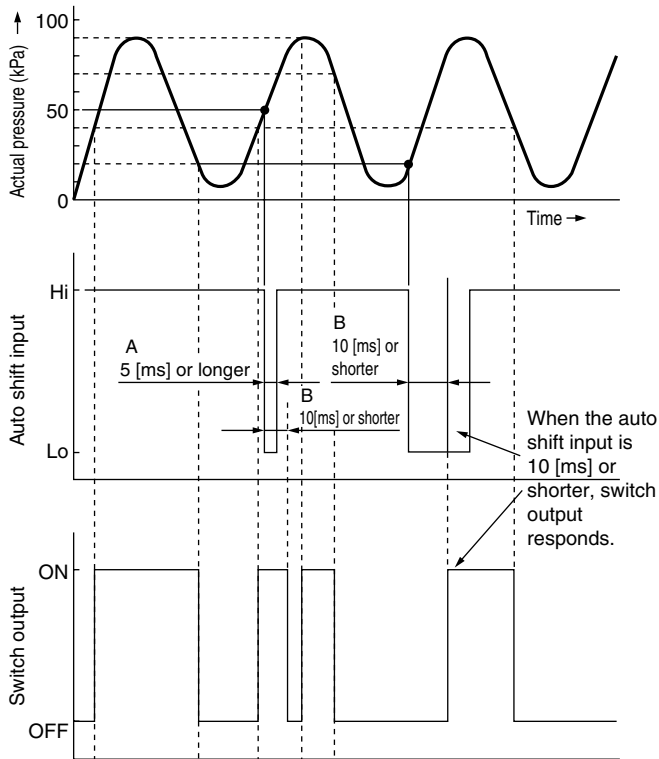

Operate in the manner same as ordinary since auto shift function is not used.

Since auto shift signal is inputted at applying 50 kPa, switching is done at pressures of 90 [kPa] and 70 [kPa].

Note) Series PSE 200 A: 10 [ms] or longer
B: 15 [ms] or shorter

13 2-wire pressure switch connections

A 3-wire type switch is a switch that has an output line other than the positive and negative lines that supply the electricity. When there are 2 outputs, 4 lines will be required in total. This type of switch belongs to the family of 3-wire type switches. 2-wire type switches have only positive and negative wires that are used for supplying the electricity from the power source and for providing the output as well.

The 2-wire type works with both the sinking type (current runs into the switch) and the sourcing type (current is flown out of the switch). It is dependant upon whether a load is connected with the positive or negative side. These switches are known for high speed response, longevity, and they can reduce wiring work.

⚠ Caution

“PS1000, PS1100”

The load current range for a PS1000 and PS1100 is between 5 [mA] and 40 [mA].

If 40 [mA] is exceeded the output transistor could be damaged. Besides, do not connect a PLC, which can detect 1 [mA], since there is a leak current of 1 [mA] in OFF state.

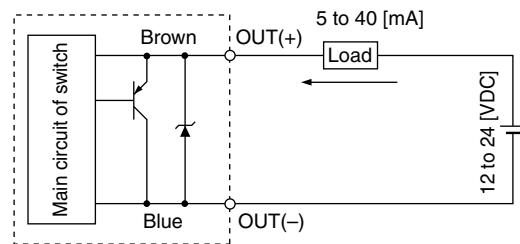

Connection example when used as a sinking type

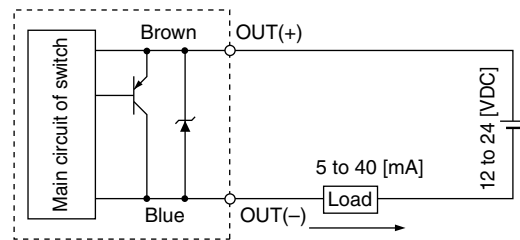

Connection example when used as a sourcing type

Connection example with PLC

NPN compliant
Sourcing type
Input unit

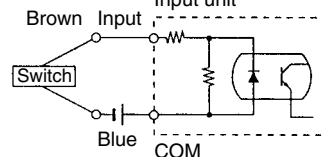

Connection example with NPN compliant, sourcing type input unit

PNP compliant
Sinking type
Input unit

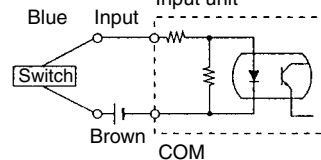

Connection example with PNP compliant, sinking type input unit

14 Voltage and current output pressure sensors

Voltage output signal is a voltage signal in the range of 1 to 5 [V]. The signal has to be converted by an A/D converter for pressure display or switch output. Current output signal is a current signal in the range of 4 to 20 [mA]. The signal is transformed into a voltage signal before being converted by a A/D converter for pressure display or switch output.

Advantages and Disadvantages (Long distance applications)

When the voltage signal has to travel any amount of distance, voltage drops occur due to the resistance of the lead wire. The voltage drop increases proportional with the resistance of the wire and thus proportional with the length of the wire.

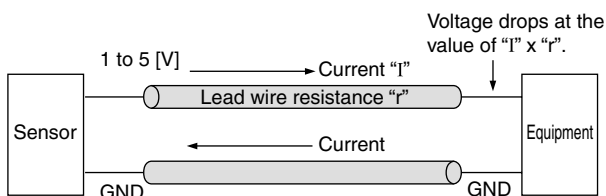

It may result in an error when the electric potential difference is caused between sensor's GND and GND of a receiver device.

Connection of the voltage output

It appears that it would be of benefit to reduce the current flow as much as possible, however if the current is reduced too much other problems, such as inductive noise from external devices, occur. Result: Voltage outputs are not suitable for long distance applications. SMC's analog outputs are all of the voltage variety, but tests have proven that there is no problem in applications of 10 [m] or less.

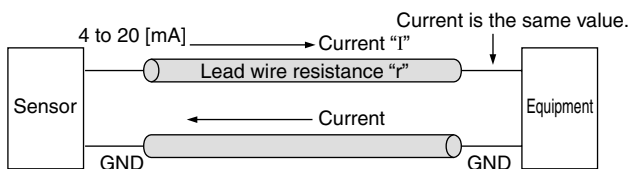

Connection of the current output

The current flow is the same regardless of the distance. The cost of a current system is higher, because the voltage signal has to be converted to a current signal on one end of the transmission line, then on the other end it has to be converted to a voltage signal again. The packaging size of a current sensor might be larger due to the size of the additional parts.

15 Protective construction

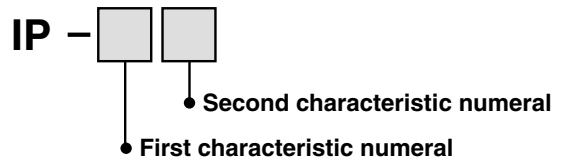

● First Characteristics: Degrees of protection against solid foreign objects

0	Non-protected
1	Protected against solid foreign objects of 50 mm ø and greater
2	Protected against solid foreign objects of 12 mm ø and greater
3	Protected against solid foreign objects of 2.5 mm ø and greater
4	Protected against solid foreign objects of 1.0 mm ø and greater
5	Dust-protected
6	Dusttight

● Second Characteristics: Degrees of protection against water

0	Non-protected	—
1	Protected against vertically falling water drops	Dripproof type 1
2	Protected against vertically falling water drops when enclosure tilted up to 15°	Dripproof type 2
3	Protected against rainfall when enclosure tilted up to 60°	Rainproof type
4	Protected against splashing water	Splashproof type
5	Protected against water jets	Low jetproof type
6	Protected against powerful water jets	Strong jetproof type
7	Protected against the effects of temporary immersion in water	Immersion type
8	Protected against the effects of continuous immersion in water	Submersible type

Example) In the case of stipulated as IP65, we can know the degrees of protection is dusttight and water jetproof on the grounds that the first characteristic numeral is 6 and the second characteristic numeral is 5 respectively, that gives it will not be adversely affected by direct water jets from any direction.

ZSE
ISE

ZSP

PS

ISA

PSE

IS

ISG

ZSM

Technical Information

16 Pressure units conversion (Approximation)

Unit								
Pa (N/m ²)	kPa	MPa	bar	kgf/cm ²	atm	mmH ₂ O or mmAq	mmHg or Torr	PSI
1	1 x 10 ⁻³	1 x 10 ⁻⁶	1 x 10 ⁻⁵	1.0197 x 10 ⁻⁵	9.8692 x 10 ⁻⁶	1.0197 x 10 ⁻¹	7.5006 x 10 ⁻³	1.4503 x 10 ⁻⁴
1 x 10 ³	1	1 x 10 ⁻³	1 x 10 ⁻²	1.0197 x 10 ⁻²	9.8692 x 10 ⁻³	1.0197 x 10 ²	7.5006	1.4503 x 10 ⁻¹
1 x 10 ⁶	1 x 10 ³	1	1 x 10	1.0197 x 10	9.8692	1.0197 x 10 ⁵	7.5006 x 10 ³	1.4503 x 10 ²
1 x 10 ⁵	1 x 10 ²	1 x 10 ⁻¹	1	1.0197	9.8692 x 10 ⁻¹	1.0197 x 10 ⁴	7.5006 x 10 ²	1.4503 x 10
9.8067 x 10 ⁴	9.8067 x 10	9.8067 x 10 ⁻²	9.8067 x 10 ⁻¹	1	9.6784 x 10 ⁻¹	1 x 10 ⁴	7.3556 x 10 ²	1.4217 x 10
1.0133 x 10 ⁵	1.0133 x 10 ²	1.0133 x 10 ⁻¹	1.0133	1.0332	1	1.0332 x 10 ⁴	7.6000 x 10 ²	1.4706 x 10
9.8067	9.8067 x 10 ⁻³	9.8067 x 10 ⁻⁶	9.8067 x 10 ⁻⁵	1 x 10 ⁻⁴	9.6784 x 10 ⁻⁵	1	7.3556 x 10 ⁻²	1.4220 x 10 ⁻³
1.3332 x 10 ²	1.3332 x 10 ⁻¹	1.3332 x 10 ⁻⁴	1.3332 x 10 ⁻³	1.3595 x 10 ⁻³	1.3158 x 10 ⁻³	1.3595 x 10	1	1.9330 x 10 ⁻²

Ex. 1) Convert the units of 350 [mmHg] to [kPa].

$$1 \text{ [mmHg]} = 1.3332 \times 10^{-1} \text{ [kPa]}$$

$$1.3332 \times 10^{-1} \times 350 = 46.662 \text{ [kPa]}$$

Ex. 2) Convert the units of 80 [kPa] to [kgf/cm²].

$$1 \text{ [kPa]} = 1.0197 \times 10^{-2} \text{ [kgf/cm}^2\text{]}$$

$$1.01972 \times 10^{-2} \times 80 = 0.81576 \text{ [kgf/cm}^2\text{]}$$

17 Operable fluids by pressure switch for general purpose fluids

Stainless steel

Metal exists in nature as ore (like oxide or sulfide). This means that oxide or sulfide is more stable than pure metal. Accordingly, metallic material chemically oxidizes (metallic constituent becomes ion and melts out). It corrodes in the natural environment.

Even though corrosion of metal easily occurs in an environment where oxidizing tendency is stronger, some kinds of metal have a characteristic for which corrosion never happens if the level of oxidizing goes higher than a specific point. In such a case, it is called "metal in passive state".

Stainless steel has corrosion resistance because of a thin coat of passive state on its surface. However, there does not exist stainless steel with absolute corrosion resistance; therefore, many types of stainless steel have been developed for improved corrosion resistance performance.

SMC Pressure Switch and Pressure Sensor for general purpose fluids have adopted stainless steel 304 or stainless steel 316L for the fittings where in contact with fluids as well as stainless steel 630 or stainless steel 316L for diaphragm of sensor part.

Corrosion resistance performance of both stainless steel 304 and stainless steel 630 is almost the same level in anti-corrosiveness property.

Caution

SMC Pressure Switch and Pressure Sensor do not have explosion-proof construction; do not use flammable gases or liquids. Also, do not use toxic gases or liquids.