

1/16 DIN Sized Controller Offers Selectable Control, Alarm Modes

- Accurate to $\pm 0.5\%$ of full scale
- Multiple temperature scale ranges allow flexibility to match application
- Field-selectable temperature ranges in $^{\circ}\text{F}$ and $^{\circ}\text{C}$
- Selectable ON/OFF and PID control with auto-tuning of proportional band
- 8-function alarm, standard
- Tamper-proof setting, faulty sensor compensation and controller diagnostics
- Easy-to-read 11 mm high LED display
- Nonvolatile memory backup
- 3-year warranty



Ordering Information

■ TEMPERATURE CONTROLLERS

Item		Part number		
Sensor input type		Thermocouple (Types J and K)	Platinum RTD (Pt: 100 Ω , DIN and JIS standards)	Interchangeable thermistor (THE types)
Output	Contact	E5CS-R1KJX-F	E5CS-R1PX-F	E5CS-R1GX-F
	Voltage	E5CS-Q1KJX-F	E5CS-Q1PX-F	E5CS-Q1GX-F

Temperature Ranges

Thermocouple Input Type

Input type	Type K						Type J					
	Temperature range	0 to 200	0 to 300	0 to 400	0 to 500	0 to 600	0 to 999	0 to 999	0 to 200	0 to 300	0 to 400	0 to 500
Scale indication	$^{\circ}\text{C}$	$^{\circ}\text{C}$	$^{\circ}\text{C}/^{\circ}\text{F}$	$^{\circ}\text{C}/^{\circ}\text{F}$	$^{\circ}\text{C}/^{\circ}\text{F}$	$^{\circ}\text{C}/^{\circ}\text{F}$	$^{\circ}\text{F}$	$^{\circ}\text{C}$	$^{\circ}\text{C}$	$^{\circ}\text{C}/^{\circ}\text{F}$	$^{\circ}\text{C}/^{\circ}\text{F}$	
Unit of measure	1 $^{\circ}$ C or F											

Platinum RTD Input Type

Temperature range	-50 to 50	0.0 to 50.0	-20 to 80	0.0 to 99.9	0 to 200	0 to 300	0 to 400	0 to 600	0 to 800
Scale indication	$^{\circ}\text{C}$	$^{\circ}\text{C}$	$^{\circ}\text{C}$	$^{\circ}\text{C}/^{\circ}\text{F}$	$^{\circ}\text{C}/^{\circ}\text{F}$	$^{\circ}\text{C}$	$^{\circ}\text{C}/^{\circ}\text{F}$	$^{\circ}\text{F}$	$^{\circ}\text{F}$
Unit of measure	1 $^{\circ}$ C or F	0.1 $^{\circ}$ C or F	1 $^{\circ}$ C or F	0.1 $^{\circ}$ C or F	1 $^{\circ}$ C or F				

Thermistor Input Type

Temp. range	-50 to 50	0 to 100	50 to 150	100 to 200	150 to 300	-50 to 100	0 to 200	100 to 300	200 to 400	300 to 600
Scale indication	$^{\circ}\text{C}$					$^{\circ}\text{F}$				
Unit of measure	1 $^{\circ}$ C or F									

■ ACCESSORIES (ORDER SEPARATELY)

Description		Part number
Protective cover	Hard plastic; protects front panel against dust, dirt and water drops	Y92A-48
Panel mounting adapter	Replacement for one supplied with each unit	Y92F-30

Specifications

Part number		E5CS-□1KJX	E5CS-□1PX	E5CS-□1GX
Sensor input type		Thermocouple Type J (IC) and Type K (CA)	Platinum RTD (Pt: 100Ω) DIN or JIS standard	Thermistor (interchangeable type)
Supply voltage		100 to 240 VAC, 50/60 Hz; operates on 85 to 110% of rated voltage		
Power consumption		Approx. 7 VA		
Control output	Contact	Type	SPDT relay	
		Max. load	3 A, 250 VAC (resistive load)	
	Voltage	Logic load	12 VDC, 20 mA with short-circuit protection	
	Hysteresis		0.2% of full scale during ON/OFF control action	
	Response time	Output	2 seconds for output to change	
		Display	2 seconds for displayed indication to change	
Service life	Mechanical	10 million operation minimum with contact output		
	Electrical	100,000 operations minimum with contact output		
Alarm output	Type	SPST-NO relay		
	Max. load	1 A, 250 VAC (resistive load)		
	Setting range	Absolute value alarm: Same as control output setting range Others: 0 to full scale		
Setting accuracy		Set value coincides with indicated value, so no relative error exists		
Indication accuracy		±0.5% of full scale, ±1 digit max.		
Display range		-999 to 999 (limited to input type)		
Control modes	Type		ON/OFF and PID with automatic tuning of proportional band, switch selectable	
	Proportional band		3% to 20% (in PID mode) automatically adjusted according to the rise time of the controlled system	
	Reset time		4 minutes (in PID mode)	
	Rate time		0.4 minutes (in PID mode)	
	Proportional period		2 or 20 seconds, switch selectable	
	Sampling period		500 ms	
Materials		Plastic case		
Mounting		Fits 1/16 DIN panel cutout; includes panel mounting adapter		
Connections		Screw terminals		
Weight		170 g (6 oz.) without mounting adapter		
Enclosure ratings	Front panel	IP50, NEMA 4 with optional Y92A-48N waterproof cover		
	Rear panel	IP30		
	Terminals	IP00		
Approvals	UL	Recognized, File Number E68481		
	CSA	Certified, File Number LR59623		
	CE	Conforms to EN61010-1		
Ambient temperature	Operating	-10°C to 55°C (14°F to 131°F)		
	Storage	-25°C to 65°C (-13°F to 149°F)		
Humidity		35 to 85% RH		
Insulation resistance		20 MΩ minimum at 500 VDC		
Dielectric strength		2,000 VAC, 50/60 Hz for 1 minute between current-carrying terminals of different polarity		
Vibration	Mechanical durability	10 to 55 Hz, 0.75 mm (0.03 in) double amplitude in X, Y, and Z directions for 2 hours each		
	Malfunction durability	2 to 55 Hz, 2 G in X, Y, and Z directions for 10 minutes each		
Shock	Mechanical durability	30 m/s ² , in 6 directions, 3 times each		
	Malfunction durability	100 m/s ² , in 6 directions, 3 times each		

Nomenclature

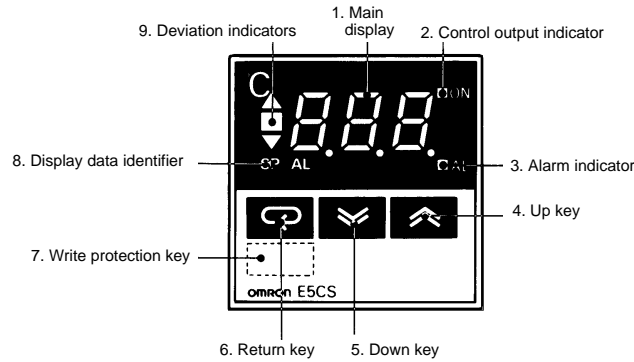

Key	Description	Key	Description
1	Main display sequentially displays the present temperature, set temperature, and an alarm value each time the return key is pressed.	7	The hidden write protection key provides protection against unauthorized setting of temperature and is used in conjunction with the internal "protection" switch. If the internal protection switch is set to ON, then to obtain Up and Down operation, the hidden key must be pressed simultaneously with the Up and Down keys. If the internal protection switch is set to OFF, changes can be made simply by pressing the Up and Down keys.
2	Control output indicator lights when the output is ON.	8	Display data identifier lights SP when the set temperature is displayed on the main display and AL when an alarm value is displayed.
3	Alarm indicator lights when the alarm output is ON.		
4	Up key increases the set temperature or alarm value when pressed. Increases the value quickly when held down.		
5	Down key decreases the set temperature or alarm value when pressed. Decreases the value quickly when held down.	9	Red deviation indicators light up an arrow when the present temperature is higher than the set temperature and light a down arrow when the present value is lower than the set temperature. The green block indicates the temperature deviation is within $\pm 1\%$ of the full scale.
6	Return key changes the value displayed on the main display each time pressed.		

Dimensions

Unit: mm (inch)

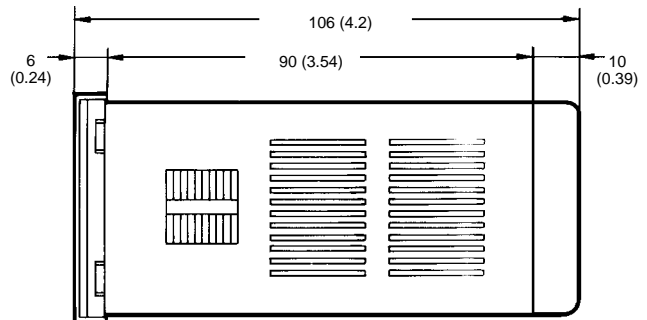
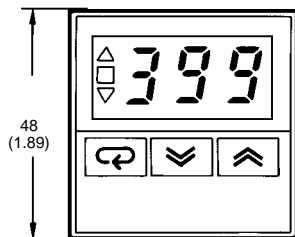
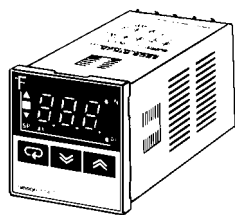

Panel Cutout

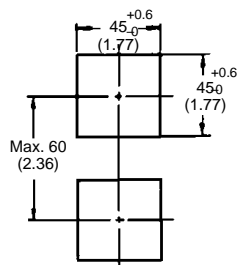

Side-by-side Mounting of Several Temperature Controllers

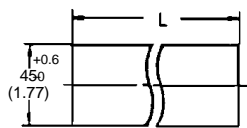

Controllers	2	3	4	5	6
L	93.5 ⁺¹ ₋₀ (3.68)	141.5 ⁺¹ ₋₀ (5.57)	189.5 ⁺¹ ₋₀ (7.46)	237.5 ⁺¹ ₋₀ (9.35)	285.5 ⁺¹ ₋₀ (11.24)

- Note: 1. Recommended panel thickness is 1 to 8 mm (0.04 to 0.31 in).
 2. Because mounting brackets are attached to the top and bottom of a temperature controller, tight side-by-side mounting is possible.

Connections

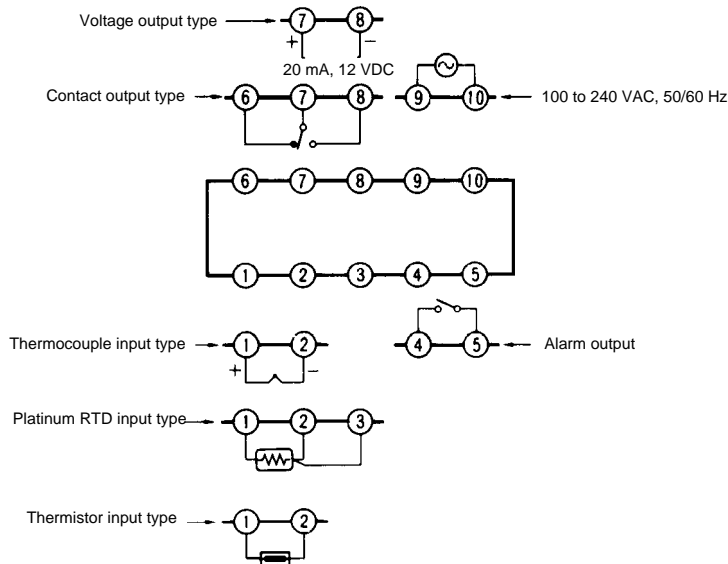

Operation

■ SETTINGS BEFORE APPLYING POWER

Note: Always turn off the power supply to the temperature controller before changing any switch settings.

Before applying power to the temperature controller, set the following selector switches to specify the temperature range, functions and alarm mode.

■ ACCESS TO INTERNAL SWITCHES AND SELECTORS

Push the tab on the underside of the front panel as you draw out the internal mechanism from the housing. The temperature range selector, and the alarm mode selector must all be set. A protection switch can also be set to protect settings. The following diagrams show the locations of these switches on the internal mechanism.

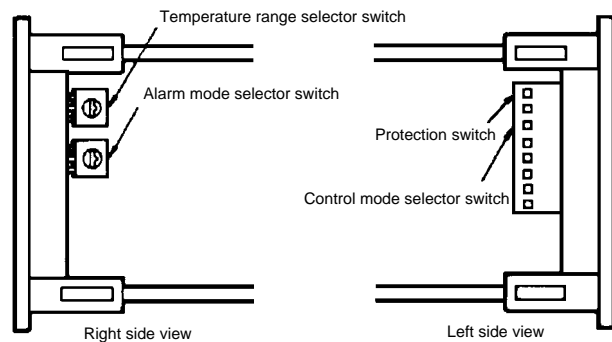
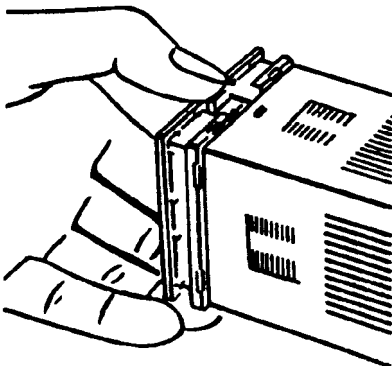

Select the desired temperature range by using the temperature range selector switch (rotary DIP type). The other rotary DIP switch is used to select one of eight alarm functions. Be sure the set temperature and alarm values are within the new range. Otherwise, the temperature controller automatically shifts these values to the maximum or minimum of the newly-set temperature range.

The protection switch may be used in conjunction with the front panel "hidden key" to prevent unauthorized changes to temperature settings. The switch is ON when it is pushed inwards in the direction of the white arrow.

The function selector switch is a 8-pin in-line DIP switch on the other side of the internal mechanism. Use it to select ON/OFF or PID control action, proportional period, control output, input shift function, temperature sensor input standard and scale indication for dual-scale temperature ranges.

FUNCTION SELECTOR SWITCH

The function selector switch is a 6-pin in-line DIP switch. The following table shows the selection made by each switch position.

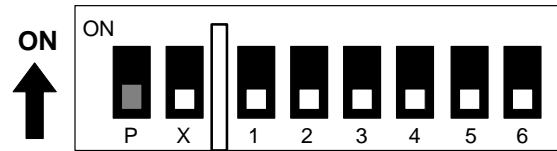

Function	Switch number	P	X	1	2	3	4	5	6
Key protection for Up/Down keys	Enables protection	ON							
	Disables protection	OFF							
Used for factory-authorized calibration only	Not used in normal operation		ON						
			OFF						
Control mode	PID action			ON					
	ON/OFF action			OFF					
Proportional period	2 seconds				ON				
	20 seconds				OFF				
Control output	Normal					ON			
	Reverse					OFF			
Input shift function	Enabled						ON		
	Disabled						OFF		
RTD sensor input standard	DIN							ON	
	JIS							OFF	
Scale indication for dual-scale range selection	°F								ON
	°C								OFF

CONTROL MODE SELECTION

ON/OFF Action

Switch 1 of the function selector DIP switch is factory-set to OFF, so the temperature controller performs ON/OFF control action. Set switch 3 to ON when the temperature controller is used to control a cooling device such as a chiller or freezer.

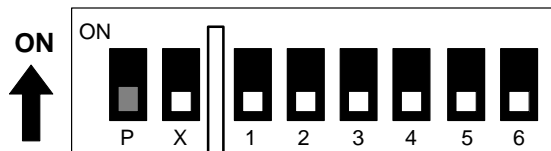

Switch 1 OFF:
Temperature controller performs ON/OFF action.

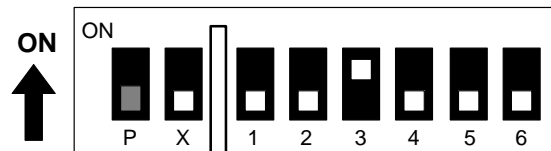
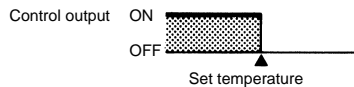

Switch 3 ON:
Used for cooling operations in ON/OFF action.

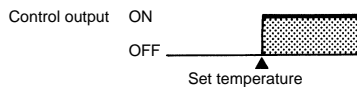

PID Action

Set switch 1 of the function selector DIP switch to ON to perform PID control action. Follow the steps described below

Determining Proportional Period

Set switch 2 of the function selector DIP switch to OFF to select a proportional period of 20 seconds. This is used when the PID control action is performed with the contact output of the temperature controller, or when using an external relay or contactor.

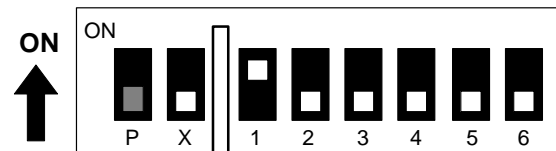

Switch 2 OFF:
Proportional period is 20 seconds.

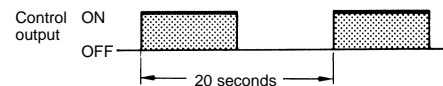

When a quick response is required, set switch 2 to ON to select a proportional period of 2 seconds. Even when a solid state relay (SSR) is used, set the 2-second proportional period only when quick response is essential. Avoid using this setting with a contact output because it will shorten the relay's service life.

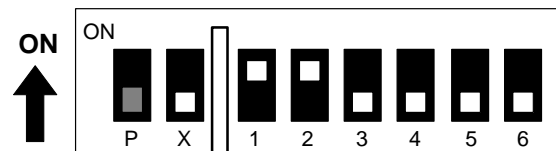

Switch 2 ON:
Proportional period is 2 seconds.

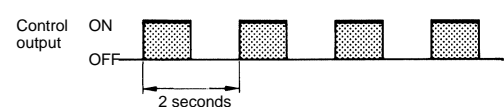

Determining Control Output Operation

If the temperature controller is used to control a heater, the control output can be set to perform a reverse (inverted) operation. Set switch 3 of the control output mode selector switch to OFF

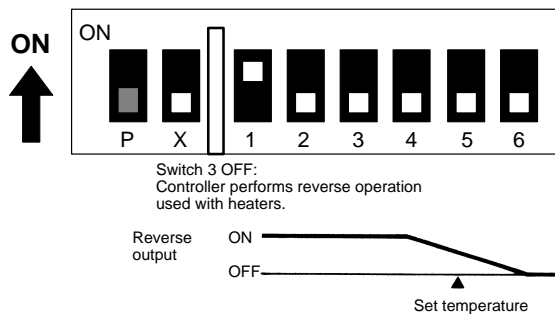

By contrast, if the temperature controller is used to control a cooling device such as a chiller or freezer, set switch 3 to ON.

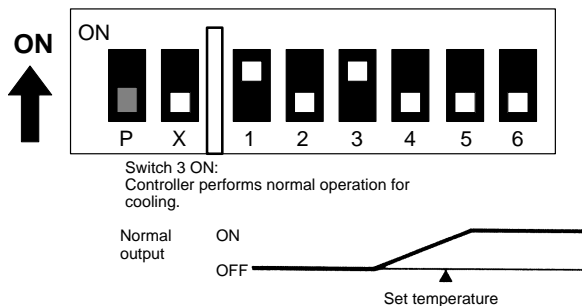

Auto-tuning of Proportional Band

Upon the initial power-up the proportional band is set to 3%. The optimum proportional band width, however, is automatically calculated and set within the range of 3 to 20%, according to the changes in the temperature of the controlled system. This automatic adjustment of the proportional band is performed regardless of whether the controlled system is a heating or cooling system.

When the power is turned OFF once, and the ON again, the control action starts with the previous proportional band. However, the new proportional band is automatically calculated and set.

The calculation of the proportional band, however, is not carried out if the temperature of the controlled system changes at a faster rate than 7.5% of full scale per 2 seconds (e.g., faster than 3.75% per °C per second with eh full scale of 100°C). In this case, the previously calculated and set proportional band is used.

The temperature controller has an overshoot suppression function that reduced second and subsequent overshoots to a level less than the initial overshoot.

INPUT SHIFT FUNCTION

The temperature indication can be shifted by setting switch 4 of the function selector DIP switch to ON, and pressing the mode key repeatedly until the message "H0" (indicating) input shift) is displayed on the main display. Then set the shift value by using the Up or Down key.

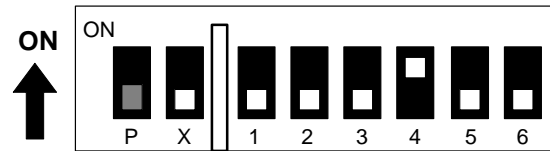

Fine adjustment of the temperature indication and the resulting controlled temperature is possible without changing or affecting the set point.

The input shift value can be set within the range from -99.9 to 99 (°F or °C).

For ranges that have resolution to 0.1, the input shift value can be set within the range from -9.9 to 9.9 (°F or °C). The input shift function may be useful to make small temperature corrections to the control system.

Note that the offset value remains effective even after switch 4 has been set to OFF. If the compensation action is not needed, be sure to set the offset value to 0.

For example:

- correction of known sensor calibration errors
- correction of known steady temperature offset between the heated work piece (load) and sensor. This is useful for applications where the sensor cannot be located exactly at the work piece.
- alignment of temperature indications in a multi-zone/multi-controller application, e.g., at ambient temperature

Note that the input shift changes the value of the controlled temperature when used in closed loop control. For example, with a set point and indication of 100°C and input shift set at +10°C, the controlled temperature will be 90°C.

Main display	Set input shift value	Temperature measured by sensor	Displayed temperature
H 0	0 offset	100°C	100°C
H 9	offset by +9°	100°C	109°C
L 9	offset by -9°	100°C	91°C

MATCHING THE CONTROLLER TO SENSOR STANDARD

Use switch 5 of the function selector DIP switch to match the controller to the thermocouple or RTD sensor to be used.

With switch 5 ON, the controller will accept DIN standard sensors. With switch 5 OFF, the controller accepts JIS standard sensors.

SELECTING SCALE INDICATION

Some dual-scale (°C/°F) temperature scale ranges may be selected by rotary DIP switch. To specify the scale indication to be displayed, used switch 6 on the in-line function selector DIP switch.

With switch 6 set to ON, the controller displays Fahrenheit scale. With switch 6 set to OFF, the controller displays Celsius scale.

■ SELECTING A SCALE RANGE

Use the rotary DIP switch to select the temperature scale range. The tables below show the switch setting number for each range. The temperature indication range is the set temperature range (full scale) $\pm 10\%$, unless otherwise noted.

If the set temperature is shifted outside of changing the scale range, the set temperature is displayed. It is then automatically

changed to the maximum or minimum value of the newly set temperature scale range.

If the alarm value is shifted outside the temperature scale range as a result of changing the scale range, it is automatically changed to the maximum value of the newly set scale range.

Thermocouple Input Type

Thermocouple input models are factory-set to switch position 2 for a temperature range of 0° to 400° , using a type K thermocouple.



Switch setting	0	1	2	3	4	5	6	6	7	8	9
Temperature range	0 to 200	0 to 300	0 to 400	0 to 500	0 to 600	0 to 999	0 to 999	0 to 200	0 to 300	0 to 400	0 to 500
Scale indication	$^{\circ}\text{C}$	$^{\circ}\text{C}$	$^{\circ}\text{C}/^{\circ}\text{F}$	$^{\circ}\text{C}/^{\circ}\text{F}$	$^{\circ}\text{C}/^{\circ}\text{F}$	$^{\circ}\text{C}/^{\circ}\text{F}$	$^{\circ}\text{F}$	$^{\circ}\text{C}$	$^{\circ}\text{C}$	$^{\circ}\text{C}/^{\circ}\text{F}$	$^{\circ}\text{C}/^{\circ}\text{F}$
Unit of measure	1° C or F										

Platinum RTD Type

Platinum RTD input models are factory-set to switch position 3 for a temperature range of 0.0° to 99.9° .



Switch setting	0	1	2	3	4	5	6	7	8
Temperature range	-50 to 50	0.0 to 50.0	-20 to 80	0.0 to 99.9	0 to 200	0 to 300	0 to 400	0 to 600	0 to 800
Scale indication	$^{\circ}\text{C}$	$^{\circ}\text{C}$	$^{\circ}\text{C}$	$^{\circ}\text{C}/^{\circ}\text{F}$	$^{\circ}\text{C}/^{\circ}\text{F}$	$^{\circ}\text{C}$	$^{\circ}\text{C}/^{\circ}\text{F}$	$^{\circ}\text{F}$	$^{\circ}\text{F}$
Unit of measure	1° C or F	$0.1^{\circ}\text{ C or F}$	1° C or F	$0.1^{\circ}\text{ C or F}$	1° C or F				

- Note: 1. Do not set the selector switch to position 9. This will cause error message "FFF" or "—" to be displayed.
 2. When changing scale ranges where the unit of measure changes 1° to 0.1° or vice versa, the set temperature also changes to reflect the unit of measure. For example, with a set temperature of 100° , a change from a scale range with 1° resolution to 0.1° makes the set temperature 10° ; with a set temperature of 15° , a change in scale range resolution from 0.1° to 1° makes the set temperature 150° .

Thermistor Input Type

Thermistor input models are factory-set to switch position 0 for a temperature range of -50° to 50°C .

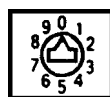

Switch setting	0	1	2	3	4	5	6	7	8	9	
Temp. range	-50 to 50	0 to 100	50 to 150	100 to 200	150 to 300	-50 to 100	0 to 200	100 to 300	200 to 400	300 to 600	
Scale indication	$^{\circ}\text{C}$					$^{\circ}\text{F}$					
Unit of measure	1° C or F										

- Note: 1. The temperature indication range for a setting scale of -50° to 50°C is -50° to 60°C . It is the full scale $\pm 10\%$ with the other setting scale ranges.
 2. With a temperature range, such as 50° to 150°C , exceeds the factory-set range, the indication unit is automatically adjusted to the minimum value. The set temperature is displayed upon power application.

SELECTING ALARM MODES

Select one of the eight alarm modes by using the rotary DIP switch located next to the rotary DIP switch for temperature scale range selection. The following table shows alarm functions. The selector switch is factory-set to position 2, upper-limit alarm.



Switch setting	Mode	Alarm output	Notes
0, 9	No alarm	OFF	When the alarm mode selector switch is 0 or 9, neither the alarm value is displayed nor the AL indicator lights even when the return key is pressed.
1	Upper- and lower-limit alarms		<p>Alarm value setting range X may be 0 to full scale.</p> <p>If the alarm value is shifted outside the temperature scale range as a result of changing the scale range, it is automatically changed to the maximum value of the newly set scale range.</p>
2	Upper-limit alarm		
3	Lower-limit alarm		
4	Upper- and lower-limit range alarm		
5	Upper- and lower-limit alarms with standby sequence		
6	Upper-limit alarm with standby sequence		
7	Lower-limit alarm with standby sequence		
8	Absolute-value alarm		

Standby Sequence

Alarm functions with standby sequence suppress nuisance alarms when the controller is first powered up. As shown in the temperature charts at right, the alarm output is suppressed until the temperature exceeds the alarm band or alarm limit one time.

When temperature rises from the set temperature

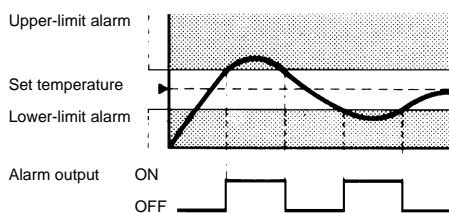

When temperature falls below the set temperature

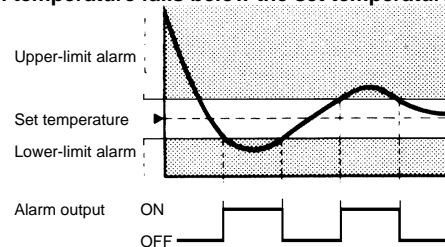

SETTING KEY PROTECTION

Protect against unauthorized changes in temperature values by disabling the operation of Up and Down keys. Set function selector DIP switch "P" to ON. To enable changes from the front panel, simultaneously press the hidden write protection key (lower left corner) with the Up and Down keys. If the internal protection switch is set to OFF, changes can be made simply by pressing the Up and Down keys.

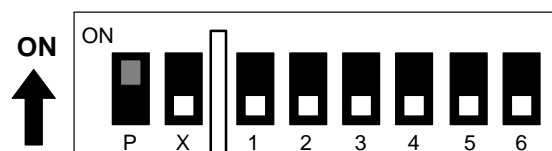

■ WHEN ALL FUNCTIONS HAVE BEEN SELECTED

To Set Temperature

Press the return key until the SP indicator lights. Then set the desired temperature value by using the Up and Down keys.

To Set Alarm Value

Press the return key until the AL indicator lights. Then set the desired alarm value in units of °F or °C. If the present temperature exceeds the set alarm value, the alarm output will be issued.

Neither the set alarm value is displayed nor the AL indicator lights with the integral alarm mode setting switch set to 0 or 9. Be sure to check the alarm mode setting switch, located inside the housing, for proper setting.

In Case of Sensor Failure

The error message "FFF" or "—" will appear on the main display if the temperature sensor short-circuits or breaks.

Precautions



The E5CS-X temperature controller has self-diagnostic functions that display the following error messages to simplify troubleshooting.

Message	Cause	Control output
FFF	(1) Temperature has risen beyond temperature scale range (2) Thermistor has been short-circuited	OFF during heating (reverse) operation ON during cooling (normal) operation
---	(1) Temperature has fallen below temperature scale range (2) Thermistor has broken	ON during heating (reverse) operation OFF during cooling (normal) operation
FFF (blinks)*	(1) Failure has occurred in thermocouple or platinum RTD (2) Temperature has risen much beyond scale range	OFF
--- (blinks)*	(1) Failure has occurred in platinum RTD (2) Polarities (positive and negative) of thermocouple are reversed (3) Temperature has fallen much below scale range	OFF
E11 or E33*	(1) Memory failure (E11) display (2) Analog-to-digital converter failure (E33) display Temperature controller must be repaired if recovery is not made by turning power off once and on again.	Both control outputs and the alarm output are OFF

Note: *Key operations are disabled.

When the alarm outputs are used, an alarm output occurs when the "FFF" and "—" messages appear in the display. These displays indicate when the temperature has risen beyond or fallen below the temperature scale range.

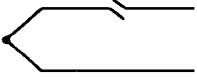
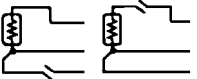
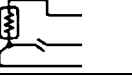
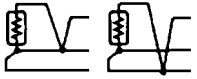
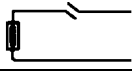
■ SENSOR FAILURE INDICATION

Condition	Display	Control output
Thermocouple sensor		
Break in sensor	 FFF blinks	OFF
Short-circuit	Ambient temperature	OFF
Platinum RTD sensor		
Break in sensor	 FFF blinks	OFF
	 --- blinks	OFF
	Disconnection of two or three wires	FFF blinks
Short-circuit	 --- blinks	OFF
Thermistor sensor		
Break in sensor	 ---	ON during heating (reverse) action OFF during cooling (normal) action
Short-circuit	 FFF	ON during heating (reverse) action OFF during cooling (normal) action

Note: The resistance of the platinum RTD is 100 Ω at 0°C and increases to 140 Ω at 100°C.

Installation

■ MOUNTING

All E5CS-X models conform to DIN 43700 standard. Recommended panel thickness is 1 to 4 mm (0.04 to 0.16 in).

Insert the temperature controller, back end first, into the panel cutout. Mount the adapter (Y92F-30) supplied with each unit by pushing it forward from the back of the temperature controller. Push the adapter as close as possible to the front panel of the temperature controller to eliminate the gap between them. Then, secure the adapter with screws as shown.

Removal

Loosen the screws on the adapter and push the hook open to remove the adapter.

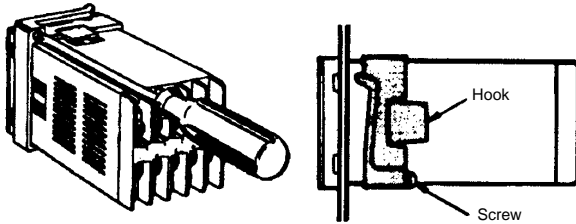

■ CONNECTIONS

Connection Examples

Use M3.5 solderless terminals with the temperature controller's M3.5 self-rising pressure plate screws.

For solder-dipped leads, strip the lead wire 6 to 12 mm (0.24 to 0.47 in) and carefully insert the wire tip. Do not tighten the terminal screw with excessive force.

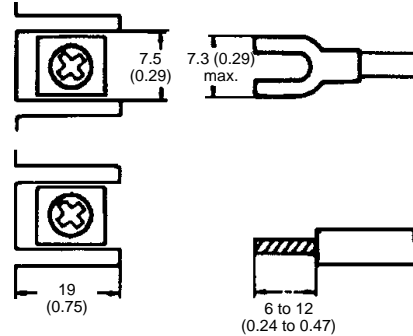

Precautions

■ ENVIRONMENT

Do not install the temperature controller in a location where there is a lot of dust or corrosive gases. Also avoid a location where the temperature controller is subjected to heavy vibration, shock, splashes of water or oil, and high temperatures. Separate the temperature controller from equipment that generates strong, high-frequency electrical noise such as welding equipment.

Sensor Input Connections

The lead wires connecting the platinum RTD to the temperature controller must be separated from the power lines and the load lines, wherever possible, to prevent them from being inducted by electrical noise.

Use the specified compensating conductors for the thermocouple input type temperature controllers.

c:/H032E12A

Use lead wires having a small resistance for the platinum RTD type temperature controllers.

Sequence Circuit

Several seconds are required until the relay is turned ON after the power has been applied to the temperature controller. Be sure to take this time lag into consideration when designing a sequence circuit which incorporates this temperature controller.

■ RECALIBRATION

The E5CS-X temperature controller can be recalibrated by a factory-authorized repair service. Contact Omron for the location near you.

Unauthorized recalibration of the controller will void the warranty and may lead to erratic operation.

OMRON[®]
OMRON ELECTRONICS, INC.
 One East Commerce Drive
 Schaumburg, IL 60173
1-800-55-OMRON

OMRON CANADA, INC.
 885 Milner Avenue
 Scarborough, Ontario M1B 5V8
416-286-6465